

AniFM S3

Veterinary Syringe Pump

Operator's Manual



© 2023 Shenzhen Mindray Animal Medical Technology Co., Ltd. All rights reserved.

For this Operator's Manual, the issued date is 2023-08

Important!

The product is for veterinary use only.

Intellectual Property Statement

Shenzhen Mindray Animal Medical Technology Co., Ltd. (hereinafter called Mindray Animal Medical) owns the intellectual property rights to this product and this manual. This manual may refer to information protected by copyright or patents and does not convey any license under the patent rights or copyright of Mindray Animal Medical, or of others.

Mindray Animal Medical intends to maintain the contents of this manual as confidential information. Disclosure of the information in this manual in any manner whatsoever without the written permission of Mindray Animal Medical is strictly forbidden.

Release, amendment, reproduction, distribution, rental, adaptation, translation or any other derivative work of this manual in any manner whatsoever without the written permission of Mindray Animal Medical is strictly forbidden.

mindray is the trademark of SHENZHEN MINDRAY BIO-MEDICAL ELECTRONICS CO., LTD. in China and other countries. All other trademarks that appear in this manual are used only for informational or editorial purposes. They are the property of their respective owners.

Responsibility on the Manufacturer Party

Contents of this manual are subject to changes without prior notice.

All information contained in this manual is believed to be correct. Mindray Animal Medical shall not be liable for errors contained herein nor for incidental or consequential damages in connection with the furnishing, performance, or use of this manual.

Mindray Animal Medical is responsible for the effects on safety, reliability and performance of this product, only if:

- All installation operations, expansions, changes, modifications and repairs of this product are conducted by Mindray Animal Medical authorized personnel;
- The electrical installation of the relevant room complies with the applicable national and local requirements;
- The product is used in accordance with the instructions for use.

Warranty

THIS WARRANTY IS EXCLUSIVE AND IS IN LIEU OF ALL OTHER WARRANTIES, EXPRESSED OR IMPLIED, INCLUDING WARRANTIES OF MERCHANTABILITY OR FITNESS FOR ANY PARTICULAR PURPOSE.

Exemptions

Mindray Animal Medical's obligation or liability under this warranty does not include any transportation or other charges or liability for direct, indirect or consequential damages or delay resulting from the improper use or application of the product or the use of parts or accessories not approved by Mindray Animal Medical or repairs by people other than Mindray Animal Medical authorized personnel.

This warranty shall not extend to

- Malfunction or damage caused by improper use or man-made failure.
- Malfunction or damage caused by unstable or out-of-range power input.
- Malfunction or damage caused by force majeure such as fire and earthquake.
- Malfunction or damage caused by improper operation or repair by unqualified or unauthorized service people.
- Malfunction of the instrument or part whose serial number is not legible enough.
- Others not caused by instrument or part itself.

Customer Service Department

Company name:	Shenzhen Mindray Animal Medical Technology Co., Ltd.
Address:	Room 702, Tower 4, YESUN Intelligent Community III, No.1301-88 Guanguang Road, Xinlan Community, Guanlan Street, Longhua District, Shenzhen 518110, P. R. China
Website:	www.mindrayanimal.com
E-mail Address:	service@mindrayanimal.com
Tel:	+86 755-33997000

Preface

Manual Purpose

This manual contains the instructions necessary to operate the product safely and in accordance with its function and intended use. Observance of this manual is a prerequisite for proper product performance and correct operation and ensures animal and operator safety.

This manual is based on the maximum configuration and therefore some contents may not apply to your product. If you have any question, please contact us.

This manual is an integral part of the product. It should always be kept close to the equipment so that it can be obtained conveniently when needed.

Intended Audience

This manual is geared for clinical professionals who are expected to have a working knowledge of medical procedures, practices and terminology as required for monitoring of critically ill animals.

Illustrations

All illustrations in this manual serve as examples only. They may not necessarily reflect the setup or data displayed on your equipment.

Conventions

- *Italic text* is used in this manual to quote the referenced chapters or sections.
- **Bold text** is used to indicate the screen texts.
- → is used to indicate operational procedures.

Contents

1 Safety	1 - 1
1.1 Safety Information	1 - 1
1.1.1 Warnings	1 - 1
1.1.2 Cautions	1 - 2
1.1.3 Notes	1 - 2
1.2 Equipment Symbols	1 - 2
2 Equipment Introduction	2 - 1
2.1 Intended Use	2 - 1
2.1.1 Contraindications	2 - 1
2.2 Main Unit	2 - 1
2.3 Screen Display	2 - 4
2.3.1 On-screen Symbols	2 - 4
2.3.2 Operation Keys	2 - 5
2.3.3 Using the Touchscreen	2 - 5
2.3.4 Using the On-Screen Keyboard	2 - 6
3 Equipment Preparation	3 - 1
3.1 Equipment Preparation Safety Information	3 - 1
3.2 Installation	3 - 2
3.2.1 Pole Clamp Installation	3 - 2
3.3 Setting Up the Equipment	3 - 3
4 Getting Started	4 - 1
4.1 Turning on the Pump	4 - 1
4.2 Loading the Syringe	4 - 1
4.3 Purge	4 - 3
4.4 Starting Infusion	4 - 4
4.5 Bolus Infusion	4 - 4
4.5.1 Automatic Bolus Infusion	4 - 5
4.5.2 Manual Bolus Infusion	4 - 5
4.5.3 Setting the Bolus Volume Unit	4 - 5
4.6 Changing the Infusion Parameters	4 - 5
4.7 Pausing the Infusion	4 - 6
4.8 Setting Keep Vein Open Rate	4 - 6
4.9 Unloading the Syringe	4 - 6
4.10 Viewing the Infused Volume	4 - 7
4.11 Entering the Standby Mode	4 - 8

4.12 Turning Off the Pump	4 - 8
5 Alarms	5 - 1
5.1 Alarm Safety Information	5 - 1
5.2 Understanding the Alarms	5 - 1
5.3 Alarm Screen	5 - 2
5.4 Resetting Alarms	5 - 2
5.5 Pausing Alarm Sound	5 - 2
5.6 Alarm Solutions	5 - 3
5.7 Occlusion Alarm	5 - 5
6 Menu Options	6 - 1
6.1 General Option	6 - 1
6.2 Department Management	6 - 2
6.3 System Options	6 - 2
6.4 User Maintenance	6 - 2
6.4.1 Device Management	6 - 3
6.4.2 Patient Information	6 - 3
6.4.3 System Calibration	6 - 3
6.4.4 Network Setup	6 - 4
6.4.5 Remote Control Setting	6 - 4
6.4.6 The Brand Management	6 - 4
6.4.7 Time and Language	6 - 5
6.4.8 The Parameter Switch Settings	6 - 5
6.4.9 The Unit Settings	6 - 5
6.4.10 The Alarm Settings	6 - 6
6.4.11 Other Setting	6 - 6
7 Infusion Modes	7 - 1
7.1 Rate Mode/Time Mode/Micro-infusion Mode	7 - 1
7.2 Dose Mode	7 - 1
7.3 Loading Dose Mode	7 - 2
7.4 Sequential Mode	7 - 2
7.4.1 Adding/Deleting Sequence	7 - 2
7.4.2 Changing the Infusion Parameters	7 - 2
7.5 Intermittent Mode	7 - 2
7.6 Ramp Mode	7 - 3
7.7 Dose Time Mode	7 - 3
8 Animal Management	8 - 1
8.1 Discharging/Admitting Animals	8 - 1
8.2 Editing Animal Information	8 - 1
8.3 Exporting Animal Information	8 - 1
8.4 Importing Animal Information	8 - 2
9 Drug Info Library	9 - 1
10 Network Communication	10 - 1
10.1 Connecting the Pump to the CMS	10 - 1
11 Maintenance	11 - 1

11.1 Maintenance Safety Information	11 - 1
11.2 Maintenance and Testing Schedule	11 - 2
11.3 Maintaining the Battery	11 - 2
11.3.1 Battery Safety Information	11 - 2
11.3.2 Installing the Battery	11 - 3
11.3.3 Charging the Battery	11 - 3
11.3.4 Conditioning the Battery	11 - 3
11.4 Disposing of the Pump	11 - 4
12 Care and Cleaning	12 - 1
12.1 Care and Cleaning Safety Information	12 - 1
12.2 Cleaning and Disinfection of the Pump	12 - 2
12.3 Sterilization	12 - 2
13 Accessories	13 - 1
A Product Specifications	A - 1
A.1 Specifications	A - 1
A.2 Wireless Network	A - 2
A.3 Infusion Specifications	A - 2
A.4 Recommended Syringes	A - 4
A.5 Occlusion Alarm Delay and Bolus Volume	A - 4
A.6 Infusion Accuracy Graphs	A - 6
A.6.1 Infusion Accuracy at 1 ml/h	A - 6
A.6.2 Infusion Accuracy at 5ml/h	A - 6
B EMC and Radio Regulatory Compliance	B - 1
B.1 EMC	B - 1
B.2 Radio Regulatory Compliance	B - 6
C Abbreviations	C - 1
D Declaration of Conformity	D - 1

1 Safety

1.1 Safety Information

WARNING

Indicates a potential hazard or unsafe practice that, if not avoided, could result in death, serious injury or damage to product/property.

CAUTION

Indicates a potential hazard or unsafe practice that, if not avoided, could result in minor personal injury, product malfunction or damage to product/property.

NOTE:

Provides application tips or other useful information to ensure that you get the most out of the product.

1.1.1 Warnings

WARNING

- To avoid risk of electric shock, the equipment must only be connected to mains power with protective earth. If a protective earth conductor is not provided, operate it on battery power, if possible.
- To avoid explosion hazard, do not use the equipment in the presence of oxygen-rich atmospheres, flammable anesthetics, or other flammable agents.
- The equipment is not intended to be used within the Magnetic Resonance (MR) environment.
- Do not use the multiple portable socket outlets (MPSO) or AC main power extension cords. Ensure that the sum of the individual ground leakage currents does not exceed the allowable limits.
- Do not open the equipment housings. All servicing and future upgrades must be carried out by trained and authorized personnel. Moreover, the servicing must be done only after the AC power supply is disconnected.
- Do not place the equipment or accessories in any position that might cause it to fall on the animal.
- Do not start an infusion unless the setup was verified to be correct.

- To avoid inadvertent disconnection, route all cables in a way to prevent a stumbling hazard. Wrap and secure excess cabling to reduce risk of entanglement by animals or personnel.
- Clearing the occlusion result from line kinks, filter coagulation, etc. may cause extra bolus to animals. Appropriate measures should be taken.
- Check that the syringe and the extension set are securely connected and there is no leakage.
- Do not touch the animal and device connectors simultaneously. Otherwise leakage current may result in animal injury.
- To avoid electric shock, do not touch animal and other non-defibrillation proof equipments during defibrillation. Defibrillation will not affect the performance of the equipment.

1.1.2 Cautions

CAUTION

- When several infusion lines are connected to the same vascular access, there may be back flow or prolonged response time of occlusion alarm. Therefore, use check valve at the line end or follow local hospitals' instructions while in connection with other infusion system. Ensure that the equipment is supplied with continuous electric power during work. Sudden power failure may cause data loss.
- Electromagnetic fields may affect equipment performance. This makes it necessary for other equipment used in the vicinity of this equipment to meet EMC standards. Mobile phones, X ray and MRI equipment are all potential interference sources because of their high-intensity electromagnetic radiation.
- Always install or carry the equipment properly to avoid damage caused by drop, impact, strong vibration or other mechanical force. The equipment should be observed to verify normal operation after fall, otherwise it cannot be used.
- Dry the equipment immediately in case of rain or water spray.
- Some settings are password protected and can only be changed by authorized personnel. Contact your department manager or biomedical engineering department for the passwords used at your facility.



1.1.3 Notes























NOTE:

- The software was developed in compliance with IEC 62304.
- The equipment provides power-down storage. Alarms limit setting and history record are saved and will be maintained if the equipment is powered down suddenly. The storage time is equals to the equipment's service life. The alarm limit settings before power-down are reloaded when the equipment is restarted.
- This manual describes all features and options. Your equipment may not have all of them.

1.2 Equipment Symbols

Some symbols may not appear on your equipment.

	Refer to instruction manual/booklet		Stacking limit by number
---	-------------------------------------	---	--------------------------

	Alternating current		Input/output
	Both direct and alternating current		Direct current
	Battery		USB connector
	Stand-by		Stop
	Non-ionizing electromagnetic radiation		General warning sign
	Date of manufacture		Manufacturer
	Serial number		CE marking
IP44	Protected against solid foreign objects of 1,0 mm Φ and greater. Protected against splashing water.		Defibrillation-proof type CF applied part
	Atmospheric pressure limitation		Humidity limitation
	This way up		Keep dry
	Fragile, handle with care		UKCA marking
	Temperature limit		
	The following definition of the WEEE label applies to EU member states only: the use of this symbol indicates that waste electrical and electronic equipment must not be disposed of as unsorted municipal waste and must be collected separately. By ensuring that this product is disposed of correctly, you will help prevent bringing potential negative consequences to the environment and human health. For more detailed information with regard to returning and recycling this product, consult the distributor from whom you purchased the product.		

2 Equipment Introduction

2.1 Intended Use

The veterinary syringe pump is used for intravenous and arterial infusion of drugs for animals.

The veterinary syringe pump is intended to be used in general wards, operation room wards and ICU of animal medical institutions.

The veterinary syringe pump must be used by or under the guidance of clinically trained medical personnel.

2.1.1 Contraindications

None.

2.2 Main Unit

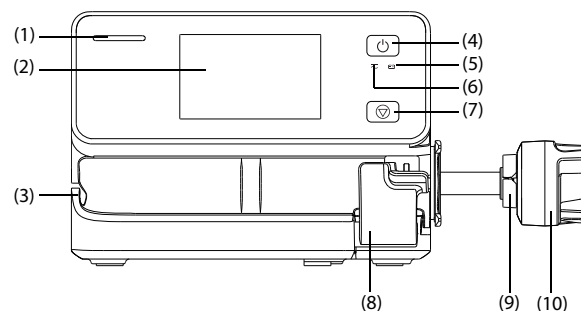

No.	Name	Description
1.	Alarm light	When a physiological alarm or technical alarm occurs, this lamp lights and flashes corresponding with the alarm priority: <ul style="list-style-type: none"> • High priority alarms: the lamp quickly flashes red. • Low priority alarms: the lamp lights in yellow without flashing.
2.	Display	/

No.	Name	Description
3.	Extension set holder	Secures the extension set.
4.	Power switch	/
5.	Battery indicator	<ul style="list-style-type: none"> • Green: the battery is being charged. • Flashing green: the pump runs on battery power. • Off: no battery is installed, or no external power is connected when the equipment is off.
6.	External power indicator	<ul style="list-style-type: none"> • On: when external power supply is connected. • Off: when external power supply is not connected.
7.	Stop key	When an emergency happens during an infusion and unlocking the touchscreen fails, press this key to stop infusion.
8.	Barrel clamp	Secures the barrel and the barrel flange to the pump and identifies the syringe barrel size.
9.	Plunger grippers	Secures the plunger to the driver head.
10.	Driver head	Presses the plunger of the syringe.

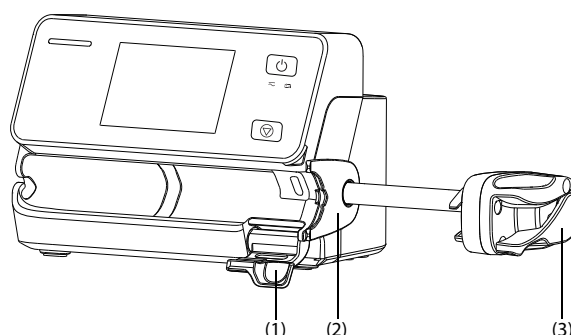

No.	Name	Description
1.	Barrel clamp	Secures the barrel and the barrel flange to the pump and identifies the syringe barrel size.
2.	Flange retainer	Secures the barrel flange to the pump.
3.	Finger grips	/

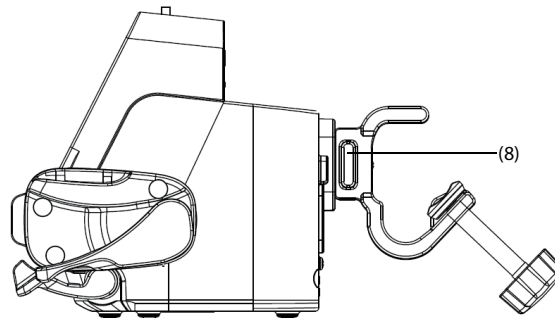
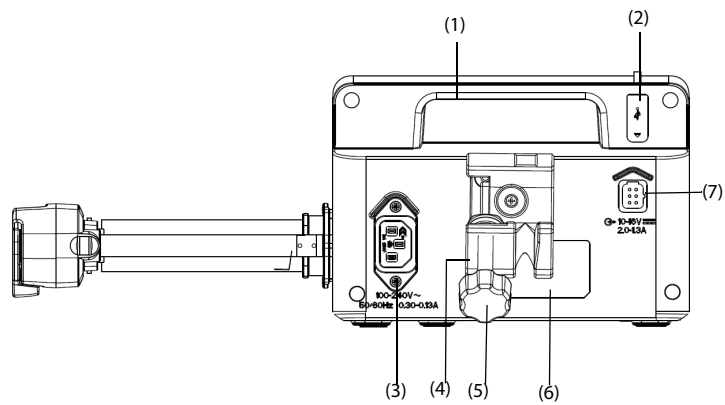

No.	Name	Description
1.	Handle	/
2.	USB connector	Connects the USB device.
3.	AC power input connector	Connects the AC power cord.
4.	Pole clamp	/
5.	Pole clamp handle	/
6.	Product label	/
7.	Multifunctional connector (optional)	<ul style="list-style-type: none"> • Uses as a DC power input connector. • Uses as a RS232 connector.
8.	Lock block	<ul style="list-style-type: none"> • Press the lock block to rotate the pole clamp. • Loosen the lock block to lock the pole clamp.

2.3 Screen Display

The screen may look slightly different in different infusion modes. The following figure shows the infusion screen of the rate mode:

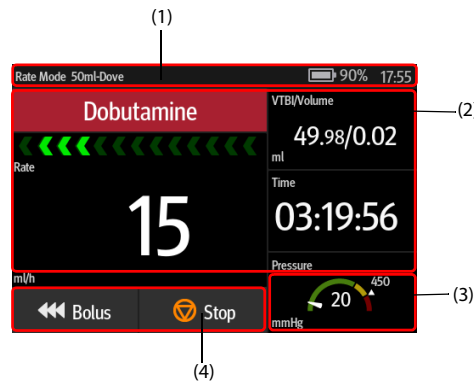



No.	Name	Description
1.	Alarm information and system status information area	Displays the alarm information, infusion mode, syringe brand.
2.	Infusion status area	Displays the drug name and major infusion parameters.
3.	Pressure status area	<ul style="list-style-type: none"> Green: pressure is normal. Yellow: pressure is near the threshold for the infusion. Red: pressure is beyond the threshold for the infusion.
4.	Key area	Displays keys.

2.3.1 On-screen Symbols

















The following table lists the on-screen symbols:

Symbol	Description	Symbol	Description
	Audible alarm tones are paused.		Alarms are acknowledged and the alarm is reset.
	Alarms are acknowledged and the reminder sound is given.		Night mode
	Wireless network is connected. The solid part indicates network signal strength.		Wireless network is not connected.
	The battery works correctly. The solid portion represents the remaining charge.		The battery is being charged.

Symbol	Description	Symbol	Description
	The battery has low power and needs to be charged.		The battery has critically low charge and needs to be charged immediately. Otherwise, the equipment will automatically shut down.
	No battery is installed, battery fault, battery communication fault, or battery charging fault. Contact service personnel for help.		

2.3.2 Operation Keys

The equipment provides operation keys for you to access some functions. The following table shows available operation keys.

Symbol	Label	Function	Symbol	Label	Function
	AudioPause	Pauses alarm sound.		AlarmReset	Acknowledges the ongoing alarms.
	Lock	Locks the touchscreen.		Purge	Initiate a purge.
	Volume	Enters the Volume menu.		Menu	Enters the Menu .
	Exit	Returns to the main screen.		Bolus	Initiate a Bolus infusion.
	Start	Starts an infusion.		Stop	Pause an infusion.
	Back	Returns to the previous screen or the parameter setup screen.		Home	Returns to the main screen.
	Setup	Enters the Standby Time setup menu or the parameter setup screen.		Cancel	Cancels the shutdown and returns to the main screen.
	Turn Off	Turn off the pump.		Standby	Enters Standby.





2.3.3 Using the Touchscreen

- Enter information
You can use the touchscreen to select a screen element by pressing directly on the pump's screen.
- Lock the touchscreen
 - To avoid misuse, the touchscreen is locked automatically if no operation is detected in the preset time.

- To manually lock the touchscreen, swipe the touchscreen from top down, and select **Lock**.
- Unlock the touchscreen
To unlock the touchscreen, select  on the touchscreen and swipe the slide as instructed.

2.3.4 Using the On-Screen Keyboard

The on-screen keyboard enables you to enter information:

- Enter the information by selecting one character after another.
- Select the Backspace key  to delete single characters.
- Select the Caps Lock key  to switch uppercase letters and lowercase letters.
- Select the Enter key  to confirm the entry and close the on-screen keyboard.
- Select the Space bar  to enter a space.

3 Equipment Preparation

3.1 Equipment Preparation Safety Information

WARNING

- Use only installation accessories specified by Mindray Animal Medical.
 - The equipment software copyright is solely owned by Mindray Animal Medical. No organization or individual shall resort to modifying, copying, or exchanging it or to any other infringement on it in any form or by any means without due permission.
 - Connect only approved devices to this equipment. Devices connected to the equipment must meet the requirements of the applicable IEC standards (e.g. IEC 62368-1 safety standards for information technology equipment and IEC 60601-1 safety standards for medical electrical equipment). The system configuration must meet the requirements of the IEC 60601-1 medical electrical systems standard. Any personnel who connect devices to the equipment's signal input/output port are responsible for providing evidence that the safety certification of the devices has been performed in accordance to the IEC 60601-1. If you have any questions, please contact Mindray Animal Medical.
 - If it is not evident from the equipment specifications whether a particular combination with other devices is hazardous, for example, due to summation of leakage currents, please consult the manufacturer or an expert in the field. A determination must be made that the proposed combination will not negatively affect the devices themselves or animal's safety.
 - Ensure that the equipment is properly secured and positioned. Position change and severe shock may lead to changes to the delivery accuracy.
-

CAUTION

- The equipment should be installed by the authorized personnel.
 - Before use, verify whether the packages are intact. In case of any damage, do not apply it to animal.
-

NOTE:

- Save the packing case and packaging material as they can be used if the equipment must be reshipped.
-

3.2 Installation

3.2.1 Pole Clamp Installation

The pole clamp secures the pump to either a horizontal or vertical bar of the medical supply unit or IV pole, or secure to pump to pet cages.

To secure the pump to a vertical bar of IV pole

Follow this procedure:

1. Press the lock block of the pole clamp, and then rotate the pole clamp to the horizontal position.

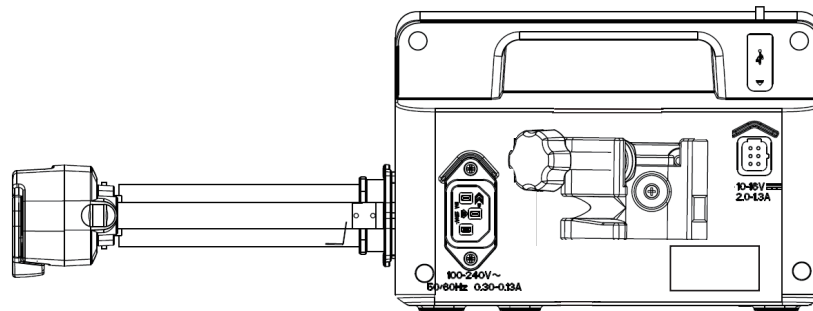

2. Rotate the pole clamp handle counterclockwise, and then loosen the pole clamp handle until the vertical bar of IV pole can be inserted.
3. Rotate the pole clamp handle clockwise to secure the pump to the vertical bar of IV pole.

To secure the pump to the horizontal bar of IV pole

Follow this procedure:

1. Press the lock block of the pole clamp, and then rotate the pole clamp to the vertical position.

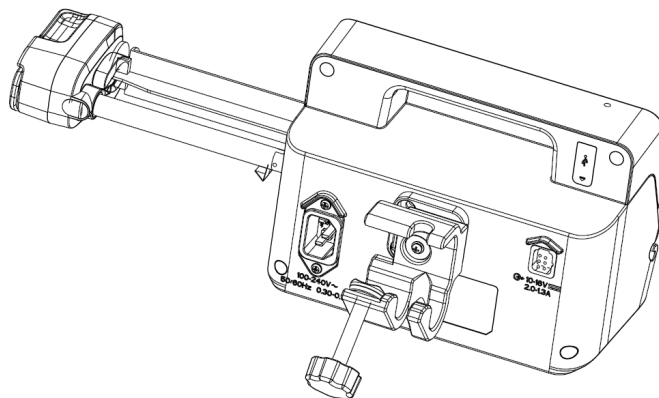

2. Rotate the pole clamp handle counterclockwise, and then loosen the pole clamp handle until the horizontal bar of IV pole can be inserted.
3. Rotate the pole clamp handle clockwise to secure the pump to the horizontal bar of IV pole.

To secure the pump to the pet cage

Follow this procedure:

1. Press the lock block of the pole clamp, and then rotate the pole clamp to the vertical position, with the pole clamp handle turning upwards.

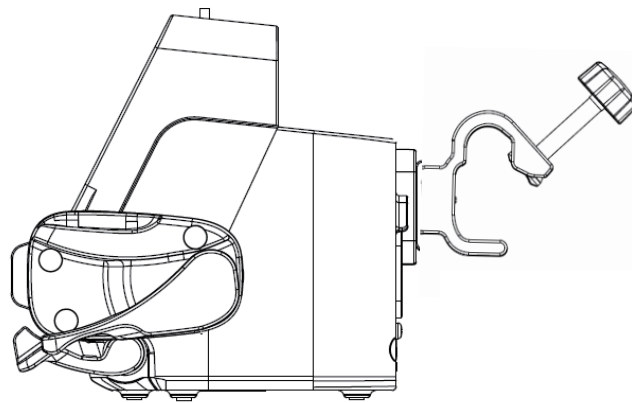

2. Rotate the pole clamp handle counterclockwise, and then loosen the pole clamp handle to secure the pump to the pet page.

3.3 Setting Up the Equipment

Before getting started, ensure that the pump is properly set up:

- The pump is placed on a stable surface, or properly mounted to an IV pole or to a pet cage using the pole clamp.
- The pump is plugged into a properly-grounded AC power outlet. When AC mains is connected, the external power indicator is illuminated in green.
- If the pump is run on battery power, ensure that the battery is adequately charged.
- To ensure the history records are stored correctly, the system date and time should be checked before first use.

WARNING

- **Always use the accompanying power cord delivered with the pump.**
 - **Before connecting the equipment to the AC mains, check that the voltage and frequency ratings of the power line are the same as those indicated on the equipment.**
 - **Do not touch the power connector with wet hand. Eliminate the liquid or any residue inside of or at the surroundings of the AC power input connector and power cord connectors.**
 - **Use the battery if the integrity of the protective earth conductor or the protective earthing system in the installation is in doubt.**
-

4 Getting Started

4.1 Turning on the Pump

Press the power switch to turn on the pump. The pump automatically performs a self test at startup. Check that the alarm tone is heard and the alarm light illuminates, one after the other, in red and yellow. This indicates that the visible and audible alarm indicators function correctly. The loading guide screen displays.

WARNING

- **Before putting the system into operation, the operator must verify that the equipment, connecting cables and accessories are in correct working order and operating condition.**
 - **Check that visual and auditory alarm signals are presented correctly when the equipment is powered on. Do not use the equipment if you suspect it is not working properly, or if it is mechanically damaged. Contact your service personnel or us.**
-

NOTE:

- Stay within 1 meter (39 inches) of the pump while setting it up and operating it, making sure that you have a clear view of the pump interface.
 - The equipment uses a mains plug as isolation means to the mains power. Do not locate the equipment in a place difficult to operate the mains plug.
-

4.2 Loading the Syringe

WARNING

- **Check that the syringe and the extension set are securely connected and there is no leakage.**
- **It is recommended that standard, single-use extension sets and syringes with Luer lock connections are used.**
- **We recommend you to use syringes and extension sets of the types and brands stated in this manual. If a non-recommended syringe must be used, perform the calibration and performance test before use. Otherwise, the accuracy of the infusion and the performance of the pump may be adversely affected.**
- **To ensure the accuracy of rate and alarm detection, the syringe size and brand should be calibrated using this pump before first use.**

- The pump must be mounted within 51 ± 5 cm above the animal's heart. The most accurate pressure monitoring in the extension set is achieved when the pump is positioned close to the animal's heart level.
- As the volume of fluid contained in the extension set and retained in the syringe at the end of infusion will not be infused, allow for this "dead space" volume when initially loading the syringe.
- Secure the extension set using the extension set holder. This provides protection against accidental dislodging of the syringe from the pump.
- Single use accessories are not designed to be reused. Reuse may cause a risk of contamination and affect the measurement accuracy.

CAUTION

- Ensure that the syringe is properly loaded. The barrel flange is in the space between the pump and the flange retainer. The plunger grippers squeeze the plunger flange. Failure to properly load the syringe could result in uncontrolled fluid flow.
- To avoid possible uncontrolled fluid flow, disconnect the pump from the animal before loading or changing the syringe. And always keep the pump under close surveillance.
- To avoid unexpected fluid flow due to height difference, place the syringe as close to the animal as possible.

NOTE:

The extension set and the pump should be placed in the same horizontal level before connected to the animal.

To load the syringe, follow this procedure:

1. Pull down the syringe clamp (1), squeeze the finger grips (2) together and slide the driver head (3) to the right.

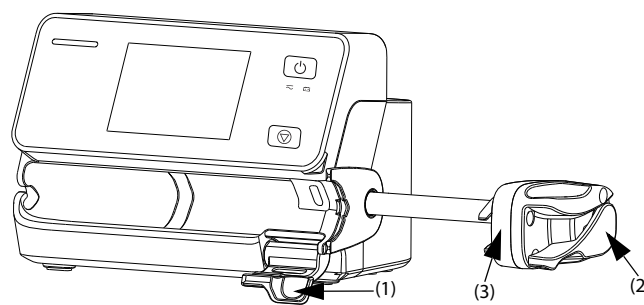

2. Place the syringe into the syringe slot (4), ensuring that the barrel flange (5) is in the space between the pump and the flange retainer (6).

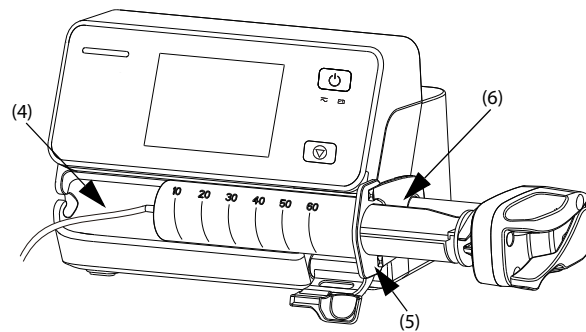

3. Lift the syringe clamp (7) until it locks the syringe barrel (8). Squeeze the finger grips together and slide the driver head (9) to the left until it reaches the plunger (10) end. Release the finger grips, and the plunger grippers (11) automatically squeezes the plunger flange (12). Place the extension line into the extension set holder (13).

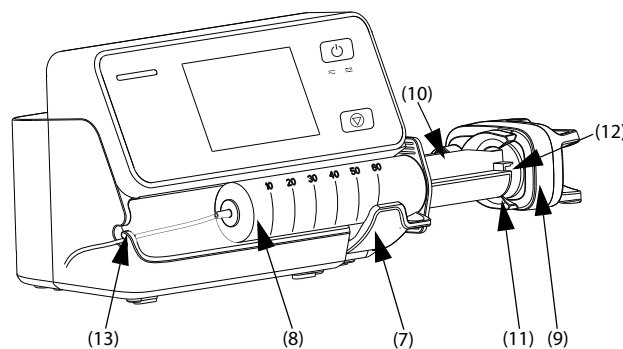



Ensure that the syringe is properly loaded.

4.3 Purge

NOTE:

- If required, set the purge rate after the purge starts. The initial purge rate is 1200 ml/h or the maximum rate that the pump can currently support according to the syringe size, whichever is smaller.
- The volume used for purging is not added to the infused volume.

The extension set and the syringe should be purged prior to being connected to an animal. If the extension set and the syringe are not purged before being loaded into the pump, proceed as follows to purge the line:

1. Ensure that the pump is disconnected from the animal.
2. Swipe the touchscreen from top down and select .
3. Select  to start purging.

4.4 Starting Infusion

WARNING

- **Do not connect animal until disposables have been purged and loaded into the pump. Connecting to animal before disposables are loaded and purged can cause serious injury or death.**
 - **Check the syringe status before infusion starts or after infusion stops, and confirm the infusion is started or stopped.**
 - **Do not put your hand around the syringe flange clamp while the driver head is moving.**
-

NOTE:

- Always discharge the previous animal before starting a new infusion for a new animal. Failure to do so can lead to data being attributed to the wrong animal.
 - Monitor the connection of syringe, extension set, pump and animal, and the drug information on a regular basis. Start infusion according to the instructions in this manual.
-

To start infusion, follow this procedure:

1. Select the syringe brand.
2. Select the drug. Select drug in the drug selection area.
3. Set the infusion mode. For more information, see “7 Infusion Modes”.
4. Set infusion parameters.
5. Connect the infusion set to the animal.
6. Check the following:
 - Verify parameter settings according to the prescriber’s order.
 - Verify that the displayed syringe brand and type correspond with the currently used syringe.
7. Press  to start infusion.

4.5 Bolus Infusion



Bolus infusion is a controlled volume of fluid or drug being delivered at an increased rate for diagnostic or therapeutic purposes. The pump should be connected to the animal during bolus infusion.

NOTE:

- The delivered bolus volume will be added to the total infusion volume and subtracted from the volume to be infused (VTBI).
 - The pump gives a beep every time a 0.5 ml bolus volume is infused.
 - If required, adjust the bolus rate in the Bolus Rate area during an automatic bolus infusion.
-

4.5.1 Automatic Bolus Infusion



To perform an automatic bolus infusion, follow this procedure:

1. Select  from the main screen.
2. Set the bolus volume in the popup dialog.
3. Select  to start an automatic bolus infusion.

The pump continues the infusion when the configured bolus volume has been infused. If required, select  to stop the bolus infusion.

4.5.2 Manual Bolus Infusion

To perform a manual bolus infusion, follow this procedure:

1. Select  from the main screen.
2. Select and hold  to start manual bolus infusion.
3. Release  when the desired bolus volume has been delivered or the bolus volume limit is reached.

NOTE:

The manual bolus volume limit is set in the **General Option** menu. For more information, see “6.1 General Option”.

4.5.3 Setting the Bolus Volume Unit

To set the bolus volume unit, follow this procedure:

1. Swipe the touchscreen from top down → select **Menu** → select **User Maintenance** → input the required password → select .
2. Select the **Bolus Volume Unit**:
 - **ml**: the **BolusVTBI** unit is **ml** in each infusion mode.
 - **Dose**: in the **Dose Mode** or **Dose Time Mode**, **Drug Amt.** and **Volume**, or **Conc.** is set up, the **BolusVTBI** unit is the **Drug Amt.** unit or the corresponding unit of the **Conc.**

4.6 Changing the Infusion Parameters

You can modify rate, dose rate, target concentration or drug name without stopping the infusion. This function is called titration.



1. Select the above parameters in the infusion running screen.
2. Reconfigure parameters in the popup dialogs.

To change other infusion parameters, follow this procedure:

1. Press  to pause the infusion.

2. Select the desired parameter area, and reconfigure parameters as per the prescriber's order.
3. Select **OK** to confirm parameter changes.
4. Press  again to resume the infusion.

4.7 Pausing the Infusion

- Press  to temporarily stop a running infusion.
- Press  again to restart the infusion after the infusion solution change.

4.8 Setting Keep Vein Open Rate

NOTE:

- If the keep vein open (KVO) rate is greater than the infusion rate, the pump will continue to infuse at the set infusion rate.
- The pump runs for 30 minutes at a KVO rate. At the completion of the KVO infusion, the pump stops infusion, and gives a KVO Finish alarm.
- The volume used during KVO infusion will be added to the total infusion volume.

At the end of infusion, the pump continues to infuse at a very low rate. KVO is used to keep the animal's vein open, to prevent back flow or vascular occlusion.

The default KVO rate is 0.5 ml/h. To edit the KVO rate, follow this procedure:

1. Swipe the touchscreen from top down → select **Menu** → select **General Option**.
2. Set the **KVO Rate**. If **KVO Rate** is zero, the pump will not initiate a KVO infusion when the preset volume is complete.

4.9 Unloading the Syringe

 **WARNING**

- **Change the extension set as per the manufacturer's instructions or the hospital regulation.**
- **To prevent free flow, make sure that the clamp has fully occluded the extension set before unloading a syringe.**

To unload the syringe, follow this procedure:

1. In the main screen, select  to stop the infusion.
2. Clamp the extension set.
3. Disconnect the animal from the extension set.
4. Remove the extension set from the extension set holder.

5. Pull down the syringe clamp, and remove the syringe from the pump.
6. Proceed the next operation as needed:
 - Continue the therapy: see “4.2 Loading the Syringe”.
 - Enter the Standby mode: see “4.11 Entering the Standby Mode”.
 - Turn off the pump: see “4.12 Turning Off the Pump”

4.10 Viewing the Infused Volume

The **Volume** dialog allows you to review the infused volume of up to 24 hours. You can also view the infused volume of the configured time interval and time length.

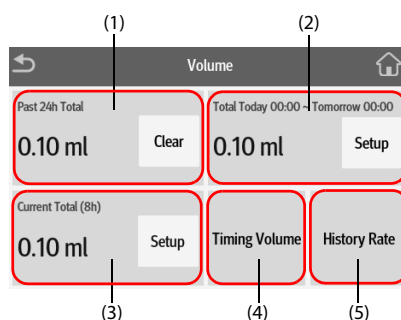

Choose either of the following ways to enter the **Volume** dialog:

- Swipe the touchscreen from top down → select Volume.
- Select Volume from the Pause screen.



No.	Description
1.	Past 24h Total: view the total infused volume in the past 24 hours. The display range is 0 ml to 99999.99 ml. Select Clear to clear the infused volume.
2.	View the recent total infused volume. Configure the time before viewing the total infused volume within the configured time.
3.	View the total infused volume in the configured time period. Configure the time period before viewing the total infused volume in the configured time period.
4.	Timing Volume: view the total infused volume of the configured timing interval. Configure the Timing Interval before viewing the total infused volume of each interval.
5.	History Rate: view the history rate.

4.11 Entering the Standby Mode

- Enter the standby mode
 - To enter the standby mode, hold the power switch and select **Standby**.
 - While the pump is in the standby mode, select  to set the standby time. The maximum standby time is 24 hours.
- Exit the standby mode
 - To manually exit the standby mode, select .

4.12 Turning Off the Pump

- To turn off the pump, press and hold the power switch and select **Turn Off**.
- If the infusion set is not removed from the pump, the pump gives prompt message **Remove infusion set to turn off**. Select **OK**, and unload the infusion set.

CAUTION

Press and hold the power switch for no less than 10 seconds to forcibly shut down the pump if it could not be shut down normally. This may cause loss of data.

NOTE:

Turning off the pump does not disconnect the pump from the AC mains. To completely disconnect the power supply, unplug the power cord.

5 Alarms

5.1 Alarm Safety Information

WARNING

- A potential hazard can exist if different alarm presets and default settings are used for the same or similar equipment in the same care area, for example an intensive care unit or cardiac operating room.
- The equipment in your care area may each have different alarm settings to suit different animals. Always check that the alarm settings are appropriate for your animal before starting infusion.
- When the alarm sound is paused, the equipment gives no alarm tones even if a new alarm occurs. Be careful about whether to pause the alarm sound or not. When the alarm sound is paused, observe the animal frequently.
- Do not rely exclusively on the audible alarm system during an infusion. Adjustment of alarm volume to a low level may result in a hazard to the animal. Always make sure that the audio alarm volume level is adequate in your care environment. Always keep the animal under close surveillance.
- Fully evaluate the risk before changing the alarm mode setting. New alarms may be failed to be detected if the operator is not familiar with the new sound.

5.2 Understanding the Alarms

By severity, the alarms are classified into the high priority alarms and low priority alarms. When an alarm occurs, the equipment indicates it visually and audibly. For more information, see the following table.

Alarm priority	Alarm lamp color	Alarm lamp flashing frequency	Alarm sound interval	Alarm message	Alarm priority indicator	Duty Cycle
High priority alarm	Red	2.0 ± 0.6 Hz	5s (±2s)	White text or symbol inside a red box	!!!	20% to 60%
Low priority alarm	Yellow	Not flashing	20s (±2s)	Black text or symbol inside a yellow box	!	100%

NOTE:

- The tones of the alarm sound and the reminder sound are different.
- The frequency of the reminder sound and the bolus sound is 600Hz, which is different from the frequency of alarm sound.
- When multiple alarms occur simultaneously, the alarm messages are displayed circularly, and the sound and light of the higher priority alarm are given.

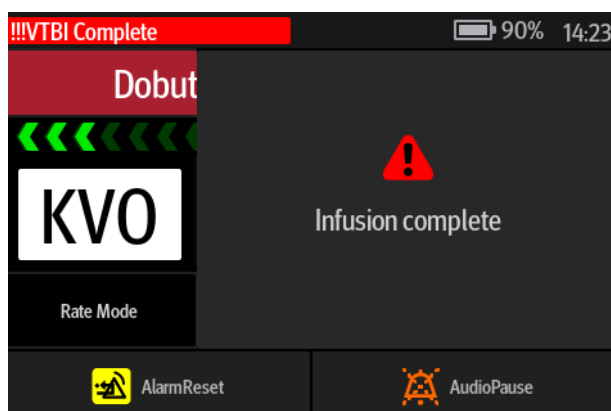

5.3 Alarm Screen

When an alarm occurs, the alarm screen is displayed to help you identify the problem.



5.4 Resetting Alarms



When an alarm occurs, press  to acknowledge and reset the alarm. The alarm reset state has the following features:

- The alarm sound is silenced, and the alarm screen disappears.
- A  appears before the alarm message, indicating that the alarm is acknowledged.
- The alarm reset symbol  is displayed after the alarm message.

For the **Syringe Empty**, **VTBI Complete**, **KVO Finish**, **Standby Time Expired** and **Extension Line Detached** alarms, when they are reset, all the alarm indications (alarm sound, alarm message, and alarm light) disappear.

5.5 Pausing Alarm Sound



To enter the audio pause state, choose one of the following ways:

- Select  in the alarm screen.
- Swipe the touchscreen from top down, and select .

The audio pause state has the following features:

- Except for the **Battery Depleted** alarm, the sound of all alarms are silenced for two minutes.
- The audio pause symbol  is displayed in the system information area.
- If a new alarm is triggered during the audio pause state, the sound of the new alarm will also be silenced.



When the audio pause time expires, the audio paused state is automatically deactivated. You can also cancel the audio paused state by pressing  again.





For the **Low Battery**, **Reminder**, **Time Near End** and **Syringe Near Empty** alarms, press  and the pump gives a reminder sound every 5 minutes. The symbol  is displayed after the alarm message.

5.6 Alarm Solutions

WARNING

When an alarm occurs, check the pump's status and handle the alarm as soon as possible. If the alarms do not conform with the actual situation, contact your service personnel.

Alarm	Priority	Causes	Solutions
Occlusion	High	An occlusion occurred and the preset pressure limit is exceeded.	Check that tubing is not kink or damaged. Check the pressure limit setting. Increase the limit if necessary.
Syringe Empty	High	No fluid is left in the syringe or the preset ml of Empty Alarm is reached.	Press  to clear the alarm. End the infusion or replace the syringe.
Syringe Disengaged	High	The syringe is disengaged.	Reload the syringe.
No Syringe	High	The syringe is not loaded properly, or start infusion when the syringe is not loaded.	Reload the syringe.
Plunger Grippers Error	High	The plunger grippers are opened during infusion.	Reload the syringe.
Extension Line Detached	Low	The extension set is disengaged.	Check and reconnect the extension set.
Syringe Near Empty	Low	The preset Time Near End is reached.	The alarm is cleared when the infusion is completed. End the infusion or replace the syringe.
Battery Depleted	High	The battery is depleted.	Connect the pump to the external power source.
VTBI Complete	High	The preset VTBI is completed.	<ul style="list-style-type: none"> • Press  to reset the alarm. • Continue therapy or select new therapy.

Alarm	Priority	Causes	Solutions
KVO Finish	High	The KVO infusion is running for thirty minutes.	<ul style="list-style-type: none"> Press  to reset the alarm. Continue therapy or select new therapy.
Relay Invalid	High	In the relay state, the upstream pumps have completed the infusions yet the downstream pumps are not ready for infusion.	Check that the downstream pumps are properly configured for infusion.
System Error	High	The pump system faults, such as storage error, hardware fault, etc.	Stop using the pump, and contact your service personnel.
KVO Running	Low	The infusion is completed and the pump continues infusion at the KVO rate.	<ul style="list-style-type: none"> The alarm is cleared after the KVO infusion reaches 30 minutes. Press  to pause the KVO infusion. Complete the infusion or prepare for a new therapy.
Battery in Use	Low	The external power source has been disconnected and the pump runs on battery power.	<ul style="list-style-type: none"> Press  to reset the alarm. Connect the pump to the external power source.
CMS/eGW Disconnected	Low	The pump is disconnected from the BeneVision CMS Vet Veterinary Central Monitoring System (CMS), the wireless network connection symbol disconnects.	Reconnect the pump with the central station, the wireless network connection symbol restores.
Standby Time Expired	Low	The preset standby time is reached.	Press  to reset the alarm.
System Time Error	Low	The real time clock (RTC) reset or RTC fault.	Reset the system time.
Relay Invalid Soon	Low	In the relay state, the upstream pumps have almost completed the infusions yet the downstream pumps are not ready for infusion.	Check that the downstream pumps are properly configured for infusion.
Time Near End	Low	The remaining infusion time reaches the configured time near end or the remaining volume reaches the set Volume Near End .	Complete the infusion or prepare for a new therapy.
Reminder	Low	No operation is detected after the preset Reminder Time is reached.	Turn off the pump or enter the standby.
Low Battery	Low	Low battery.	Connect the pump to the external power source.

Alarm	Priority	Causes	Solutions
Para. Unconfirmed	Low	No operation is detected for 10 seconds in the parameter edit state.	<ul style="list-style-type: none"> Press  to acknowledge the alarm. Edit and confirm the parameter setting.

NOTE:

- The pump stops infusion when a high priority alarm is triggered.
- The pump continues infusion when a low priority alarm is triggered.
- The pump stops infusion after the **Battery Depleted** alarm occurs, and the shutdown delay is at least three minutes.

5.7 Occlusion Alarm

Signals collected by the built-in pressure sensor is used for pressure calculation by the internal Central Processing Unit (CPU). The calculated pressure value is compared with the set occlusion alarm limit, the pump gives prompt message **Pressure increasing.Occlusion?** when the pressure continuously increases for some time. The pump stops the infusion and gives an **Occlusion** alarm when the pressure exceeds the set limit.

The occlusion alarm delay time is subject to the syringe brand and size. If this pump is running at 5ml/h using B.Braun Original Perfusor Syringe 20ml and 50ml syringes, and configure the occlusion pressure alarm limit to 450mmHg, the occlusion alarm delay time may reach up to four minutes and 13 minutes, the bolus volume after occlusion may reach up to 0.10ml and 0.15ml. Occlusion pressure should be configured according to animal needs, to facilitate view the occlusion.

The pump restarts the infusion when the pressure that caused the alarm is reduced. When the number of auto restarts has been reached, the infusion will not restart after an occlusion alarm. A bolus reduction is automatically initiated by the pump after the restart is failed or the occlusion alarm is reset.

The auto restart function can be configured in the **User Maintenance** menu, see “6.4.11 Other Setting”.

6 Menu Options

6.1 General Option

Swipe the touchscreen from top down → select **Menu** → select **General Option**.

Menu Item	Function
Reminder Time	Set for how long the Reminder alarm is triggered since the pump is last operated.
Lock Time for No Infusion	Set for how long the touchscreen automatically locks since the pump is last operated while the pump is not infusing.
Lock Time in Infusion	Set for how long the touchscreen automatically locks since the pump is last operated while the pump is infusing.
Near End Alarm	Alarm Method: Set the mode of Time Near End and Syringe Near Empty alarms. When the switch is turned off, the pump does not give the Time Near End and Syringe Near Empty alarms.
	Time Near End: Set for how long the Time Near End alarm is triggered since the infusion is completed.
	Volume Near End: Set the volume amount that the Time Near End and Syringe Near Empty alarms are triggered since the infusion is completed.
Bolus Limit	Auto: sets the upper limit of the auto bolus volume setting. If the set bolus volume exceeds the limit, the pump prompts you to reconfigure the bolus volume.
	Manual: sets the maximum volume of a manual bolus infusion. The manual bolus infusion stops when the set volume is reached.
Dose Rate Unit	Set the dose rate unit for infusion modes.
Common Dose Unit	Check or uncheck the dose unit.
Common Mode	Check or uncheck the infusion mode. The checked infusion mode will be displayed in the infusion mode list of the infusion status area.
Large Font	Set parameters that can be displayed in the large font screen.

6.2 Department Management

Menu Item	Function
Applied Department	/
Config Management	Modify the parameter settings of the applied departments. After the parameters of configuration management are changed, the settings of general option and system options will be changed synchronously.

6.3 System Options

Swipe the touchscreen from top down → select **Menu** → select **System Options**.

Menu Item	Function
Sound Volume	Set the sound volume.
Brightness	Set the screen brightness.
Brightness On Battery	Set the screen brightness when the pump runs on battery power.
History Record	View the history record.
Export History Record	Export the history record.
Night Mode	Set the night mode switch, start time, end time, system volume, and screen brightness.
Version Information	View the software version, brand library, drug library version, and Wi-Fi version.

6.4 User Maintenance

CAUTION

The maintenance settings can only be changed by authorized personnel. Contact your department manager or biomedical engineering department for the passwords used at your facility.

Swipe the touchscreen from top down → select **Menu** → select **User Maintenance** → input the required password → select .

6.4.1 Device Management

Menu Item	Function
Facility	Inputs the facility, the Department and the device name.
Department	
Device Name	
Device ID	Displays the device ID.

6.4.2 Patient Information

Menu Item	Function
Patient ID	Selects whether the items can be displayed and edited from the Patient Management menu.
Visit Number	
Patient Location	<ul style="list-style-type: none"> • Fixed: After an animal is discharged, only animal data are removed from the pump, the Bed No. and Room No. are retained. • Unfixed: After an animal is discharged, animal data, Bed No., and Room No. are all removed from the pump.
Auto Discharge When Power Off	<ul style="list-style-type: none"> • Never: The animal is not discharged automatically after the pump is turned off. • Immediate Discharge: The animal is discharged automatically after the pump is turned off.

6.4.3 System Calibration

Menu Item	Function
Accuracy Calibration	Contact your service personnel to perform the calibration as per the recommended frequency in “13.2 Maintenance and Testing Schedule”.
Pressure Calibration	Contact your service personnel to perform the calibration as per the recommended frequency in “13.2 Maintenance and Testing Schedule”.
Data Review	Reviews the calibration data.
Testing Data Review	Reviews the testing data.

6.4.4 Network Setup

Menu Item		Function
WLAN	SSID	/
	Password	/
	Security	Selects the security method.
	WLAN Setup	Sets the WLAN band.
WLAN IP	DHCP Switch	Selects whether to enable the function of automatically getting the IP address.
	IP Address	Sets the IP Address , Subnet Mask and Gateway .
	Subnet Mask	These settings are not available if DHCP switch is turned on.
	Gateway	
	MAC Address	
Central Station Setup	Central Station IP Address	Sets the central station IP address.
Device Discover	Multicast TTL	Multicast helps device discovery between pumps and between pumps and CMS. Devices in the same multicast group can be mutually discovered.
	Multicast Address	
	Master Server IP Address	Displays master server IP address.
	Connected Status	Displays network connection status.

6.4.5 Remote Control Setting

Menu Item	Function
Remote Control	/
Control Authorization Code	Sets the authorization code for the current device.
Restore Authorization Code	Restore the authorization code to the default value (device number).

6.4.6 The Brand Management

Menu Item	Function
Common Brand	Checks or unchecks the brand, and select Confirm . The checked brand will be displayed in the brand list.

Menu Item	Function
Add Brand	<p>Adds a brand by this procedure:</p> <ul style="list-style-type: none"> • Input the brand name → select a type (Regular, or Light-sensitive) → select the syringe volume → select Confirm. • The added brand is displayed in the Common Brand menu.
Delete Brand	<ul style="list-style-type: none"> • Selects the undesired brand, and select Confirm to delete this brand. • The build-in brand is not allowed to be deleted.
Modify Brand	<ul style="list-style-type: none"> • Selects the brand that needs modifying, modify this brand and select . • The build-in brand is not allowed to be modified.

6.4.7 Time and Language

Menu Item	Function
Date	Sets the current date.
Time	Sets the current time.
Date Format	Sets the date format.
24 h	Sets the time format. If you want to use the 12-hour mode, switch off 24 hour time.
Language	Sets the language. This setting is effective after the pump has been restarted.

6.4.8 The Parameter Switch Settings

Menu Item	Function
0.01 ml/h	If this switch is turned on, 0.01 ml/h is available for the Rate setting.
50 mmHg	If this switch is turned on, 50 mmHg is available for the OcclusionPressure setting.

6.4.9 The Unit Settings

Menu Item	Function
Pressure Unit	Sets the pressure unit. The options include: mmHg, kPa, bar, and psi.

Menu Item	Function
Weight Unit	Sets the weight unit. The options include: kg and lb.
Height Unit	Sets the height unit. The options include: cm and inch.

6.4.10 The Alarm Settings

Menu Item	Function
Alarm Sound	Sets the alarm sound mode.
CMS/eGW Disconnected Alarm	Sets whether the disconnection alarm will be enable.
Empty Alarm Mode	Sets the mode of Syringe Empty and Syringe Near Empty alarms. <ul style="list-style-type: none"> • Remaining Volume: If the VTBI is not set, the remaining time is displayed as countdown time. • Pressure: If the VTBI is not set, the remaining time is displayed as < 15 min.
Strengthen Syringe Near Empty	Sets whether to strengthen the Syringe Near Empty alarm. If this switch is turned on, after the Syringe Near Empty alarm is triggered, the yellow alarm lamp flashes, and the alarm sound interval can be shorten.
Strengthen Time Near End	Sets whether to strengthen the Time Near End alarm. If this switch is turned on, after the Time Near End alarm is triggered, the yellow alarm lamp flashes, and the alarm sound interval can be shorten.

6.4.11 Other Setting

Menu Item	Function	
Bolus Volume Unit	ml	Sets the unit of bolus volume.
	Dose	
Purge Limit	/	Sets the maximum volume of the purge. The purge stops when the set volume is reached. The setting range is 0.01 ml to 5 ml.
Para. Memory	/	Sets the parameter memory switch. If this switch is turned on, the pump can automatically reload the infusion mode and other infusion parameters when restarted if the same drug has been selected.
Loading Guide	/	Sets whether enter the loading guide screen when the syringe is not loaded.

Menu Item		Function
Brand Selection	/	Sets whether the brand list will be displayed after the syringe is loaded or replaced.
Auto-restart	/	Sets whether to restart the infusion or not when the occlusion pressure is reduced.
Select drug during infusion	/	Sets whether the drug can be selected during the infusion.
Drug Selection Popup	/	Sets whether to enable drug infusion popup.
Department Management	Drug Management	Sets whether to enable drug management.
	Department Management Password	Sets whether to enable drug management password.
Drop Sensor	/	Sets whether to enable drop sensor
KVO	/	Selects whether to enable the KVO function.
Concentration Config	Conc.	Sets the concentration parameter for Dose Mode, Dose Time Mode. <ul style="list-style-type: none"> • Conc.: The concentration parameter is displayed as Conc. in the above mode. • Amount & Volume: The concentration parameter is displayed as Drug Amt. and Volume in the above mode.
	Amount & Volume	
Modify Password	/	Modifies the password for accessing the User Maintenance menu.
Import and Export	/	<ul style="list-style-type: none"> • Imports configuration file, drug library or brand library. • Exports configuration, brand library, or drug library.
Version Information	/	Displays software version, algorithm, brand library, drug library type, and Wi-Fi version, etc.

7 Infusion Modes

The pump provides the following infusion modes: Rate Mode, Time Mode, Micro-infusion Mode, Dose Mode, Loading Dose Mode, Sequential Mode, Intermittent Mode, Ramp Mode, Dose Time Mode.

7.1 Rate Mode/Time Mode/Micro-infusion Mode

In rate mode, time mode, and micro-infusion mode, the IV drug therapy continues to infuse at a set rate. Micro-infusion mode is typically use for low rate infusions. The infusion modes offer four parameters: rate, time, VTBI and Conc. When two of rate, time and VTBI are entered, the third is calculated.

NOTE:

When infusing in the rate mode, time mode, and micro-infusion mode, you must set rate, but time and VTBI settings are optional.

7.2 Dose Mode

Dose mode allows you to specify the drug amount, diluent volume or concentration for a therapy. Dose mode is typically used for body weight drugs. The calculation formulas are as follows:

- $\text{Rate} = \text{Dose Rate} * \text{Weight} / \text{Conc.}$
- $\text{Dose Rate} = \text{Rate} * \text{Conc.} / \text{Weight}$
- $\text{Time} = \text{VTBI} / \text{Rate}$
- $\text{Conc.} = \text{Drug Amt.} / \text{Volume}$

You can change the concentration parameters (**Drug Amt.**, **Volume** or **Conc.**) and weight unit as needed.

NOTE:

- Time can only be obtained by calculation. It is not available for manual input.
 - Some departments may use fixed drug amounts, diluent volumes, or concentrations. Using the drug info library to predefine these infusion parameters can simplify the setting process.
-

7.3 Loading Dose Mode

In the loading dose mode, an infusion is divided into two stages:

- Deliver the loading dose at the loading dose.
- Deliver the remaining volume (VTBI minus **Loading Dose**) at the primary rate.

NOTE:

If you do not configure the loading dose parameters, the pump infuses at the Primary Rate until the set VTBI is finished.

7.4 Sequential Mode

In sequential mode, you can set several parameter groups. Each group defines a set of parameters: rate, time and VTBI. The pump infuses at the set sequence. You can add up to eleven sequences in the sequential mode.

7.4.1 Adding/Deleting Sequence



You can add up to eleven sequences in the sequential mode. To add or delete a sequence, follow this procedure:

1. Select a sequence (such as S1) from the parameter setup screen.
2. In the popup dialog, make the following settings:
 - Select **Add Sequence Upward** to add a sequence before the current sequence.
 - Select **Add Sequence Backward** to add a sequence after the current sequence.
 - Select **Delete** to delete the current sequence.

7.4.2 Changing the Infusion Parameters

You can change the rate of the current sequence during an infusion. If you want to change the time or VTBI of the current sequence, press  to pause the infusion and select the desired parameter area to make the change.

To change parameters of other sequences, follow this procedure:

1. Press  to pause the infusion.
2. Select .
3. Select the desired parameter area to make the change.

7.5 Intermittent Mode

In the intermittent mode, intermittent infusion and maintenance are performed alternately and circularly.

- Intermittent stage: the pump runs the high rate infusion at the set **Rate** and **Intmt. Vol.**
- Maintenance stage: the pump runs the low rate infusion at the set **Maintain Rate** and **Intmt. Time**. The pump does not infuse at this stage if the Maintain Rate is not set.

NOTE:

Total VTBI and Maintain Rate are optional parameters. If the Maintain Rate is not set, infusion stops at the maintenance stage. If the Total VTBI is not set, the infusion stops when the syringe is empty.

7.6 Ramp Mode

In the ramp mode, the infusion is running at increasing or decreasing rates.

- Ramp up stage: in the set ramp up time, the infusion rate increases until steady rate is reached.
- Steady stage: the pump infuses at a steady rate.
- Ramp down stage: in the set ramp down time, the infusion rate decreases until the set VTBI is completed.

NOTE:

- The Steady Rate can only be obtained by calculation. It is not available for manual input.
 - Up Time and Down Time are optional parameters. The pump runs an infusion at the steady rate if they are not set.
-

7.7 Dose Time Mode

The dose time mode allows the clinician to specify the drug amount, diluent volume or concentration. The dose mode is typically used for body weight independent drugs. The calculation formulas are as follows:

- $\text{Rate} = \text{Dose Rate} / \text{Conc.}$
- $\text{Dose Rate} = \text{Rate} * \text{Conc.}$
- $\text{Time} = \text{VTBI} / \text{Rate}$
- $\text{Conc.} = \text{Drug Amt.} / \text{Volume}$

You can change the concentration parameters (**Drug Amt.**, **Volume** or **Conc.**) as needed.

8 Animal Management

8.1 Discharging/Admitting Animals

Before admitting a new animal, discharge the previous animal. After the animal is discharged, all animal data are removed from the pump. After a animal is discharged, the pump automatically admit a new animal.

To manually discharge a animal, follow this procedure:

1. Swipe the touchscreen from top down → select **Menu** → select **Discharge Patient**.
2. Select **Accept**.

The animal is automatically discharged in the following cases:

- After the animal data is successfully exported through the USB drive. For details, see “8.4 Importing Animal Information”
- After the animal is discharged by the CMS or the monitor.

8.2 Editing Animal Information

Edit animal information after a animal has been admitted, or when animal information is incomplete, or when you want to change animal information.

To edit animal information, follow this procedure:

1. Swipe the touchscreen from top down → select **Menu** → select **Patient Management**.
2. Edit animal information as required.

8.3 Exporting Animal Information

To export the information of the current animal to the USB drive, follow this procedure:

1. Connect the USB drive to the USB connector.
2. Swipe the touchscreen from top down → select **Menu** → select **Patient Management** → select **Export Patient Information**.
3. Select **OK**.

After exporting the animal information, the pump automatically discharges the animal.

8.4 Importing Animal Information

To import the animal information from the USB drive, follow this procedure:

1. Connect the USB drive to the USB connector.
2. Swipe the touchscreen from top down → select **Menu** → select **Patient Management** → select **Import Patient Information**.
3. Select **OK**.

9 Drug Info Library

The pump can be configured with a drug info library, which predefines drugs, concentrations, occlusion pressure levels and other infusion parameters. Using a drug info library simplifies the infusion operation, and reduces the risk of operation fault.

The drug info library are created, edited, and imported via their respective PC programs. They have the following features:

- Saving at least 5000 drug names.
- At least 30 colors are available for drug marking.
- Supporting at least 30 drug categories.
- Predefining drugs, concentrations, occlusion pressures, KVO rate, bolus volume limit.
- You can predefine the infusion modes and corresponding parameters in the drug info library. When the drug is selected, the pump automatically load the infusion mode and corresponding parameters.

CAUTION

- **The drug info library should be created by professionals. Checked that the drug and parameter settings are suitable for the care area before use.**
 - **The facility is responsible for performing initial checks to ensure that the proper drug info library is loaded.**
-

10 Network Communication

The pump can be connected to the CMS.

CAUTION

- **Wireless network designing, deploying, debugging, and maintenance should be executed by the service personnel or authorized technicians.**
 - **Always set the wireless network according to local wireless regulations.**
 - **Data communication for all network functions must be performed within a closed network or within a virtually isolated network provided by a hospital. The hospital is responsible for ensuring the security of the virtually isolated network.**
 - **Keep network authentication information, for example password, safe, protecting the network from being accessed by unauthorized users.**
 - **Do not connect non-medical devices to the network.**
 - **If wireless network signal is poor, there may be a risk of CMS data loss.**
 - **RF interference may result in wireless network disconnection.**
 - **Disconnecting from the network may result in CMS data loss and function failure. Check the animal in case of network disconnection and solve the network problem as soon as possible.**
 - **Ensure that the IP address setting is correct. Changing the network settings may result in network disconnection. Contact your service personnel if you have any problems on setting the IP address.**
-

10.1 Connecting the Pump to the CMS

The pump can be connected to the CMS through the wireless network. When connected to the CMS, the system provides the following functions:

- The pump can transmit infusion information, alarm information, and pump information (such as battery and network) to the CMS.
- Animal information can be synchronized between the pump and the CMS.
- Animal can be admitted or discharged by the CMS, and animal information can be transmitted to this pump.

To connect the pump to the CMS, follow this procedure:

1. Set **IP Address**, **Subnet Mask**, and **Gateway**. For details, see “6.4.4 Network Setup”.
2. Connect the pump to the CMS through one of the following methods:

- Admit the pump on the CMS. Refer to the *BeneVision CMS Vet Veterinary Central Monitoring System Operator's Manual* for details of admitting the pump.
- Pair the pump on the CMS. Refer to the *BeneVision CMS Vet Veterinary Central Monitoring System Operator's Manual* for details of pairing the pump.
- Set the **Central Station IP Address** in the **User Maintenance** menu, and the pump automatically search and connected to the corresponding CMS. For the setting of **Central Station IP Address**, see “6.4.4 Network Setup”.

NOTE:

The pump can communicate with the CMS only when it is properly connected the CMS. If the network is interrupted, you are not able to view the infusion information through the CMS.

11 Maintenance

Regular maintenance is essential to ensure that the pump functions properly. This chapter contains information on periodic testing and maintenance.

11.1 Maintenance Safety Information

WARNING

- **To avoid electric shock, stop using the pump if you find the housing of the pump has signs of broken. Contact the service personnel for help in that case.**
 - **Failure on the part of the responsible individual hospital or institution using this pump to implement a recommended maintenance schedule may cause undue pump failure and possible health hazards.**
 - **No modification of this pump is allowed.**
 - **This pump contains no user serviceable parts.**
 - **The safety checks or maintenance involving any disassembly of the pump should be performed by professional service personnel. Otherwise, undue pump failure and possible health hazards could result.**
 - **The service personnel must be properly qualified and thoroughly familiar with the operation of the pump.**
-

CAUTION

- The pump and accessories shall not be served or maintained while in use with an animal.
 - If you discover a problem with the pump, such as the product label falls off or illegible, contact your service personnel.
-

NOTE:

If needed, contact the manufacture for circuit diagrams, component part lists, descriptions, calibration instructions, or other information concerning the repair of the pump.

11.2 Maintenance and Testing Schedule

Follow the maintenance and testing schedule or local regulations to perform testing and maintenance. Make sure to clean and disinfect the pump before taking any tests and maintenance. The following table lists the maintenance and testing schedule:

Test/Maintenance Item	Recommended Frequency	
Performance Tests		
Tests required by IEC 60601-2-24	<ul style="list-style-type: none"> Once every three years. When you suspect that the occlusion alarm is abnormal. When you suspect that the rate is abnormal. The syringe is not properly recognized. The Syringe Empty alarm is not properly presented. 	
Safety Tests		
Electrical safety tests required by IEC 60601-1	<ul style="list-style-type: none"> Once every three years, or if required. When the power board is repaired or replaced. When the main board is replaced. When the pump drops to the ground. 	
Other Tests		
Visual inspection	Every day, before first use.	
Power-on test	Each time the pump is powered on.	
Battery check	Functionality test	<ul style="list-style-type: none"> When the battery is first installed. When the battery is replaced.
	Performance test	Every four months or if the battery runtime reduces significantly.
Pressure calibration, syringe calibration, and sensor calibration.	If the performance test fails. For more information, see the service manual.	

Except the regular check and battery check, all other test and maintenance tasks should be performed by the qualified service personnel only. If your pump needs a safety test and performance test, contact the service personnel.

11.3 Maintaining the Battery

11.3.1 Battery Safety Information

WARNING

- Use only specified battery. Use of a different battery may present a risk of fire or explosion.
- The battery must only be installed and replaced by service personnel trained and authorized by Mindray Animal Medical.
- Do not crush, drop or puncture the battery. Mechanical abuse can lead to internal damage and internal short circuits. If a battery has been dropped or banged against a hard surface,

whether damage is externally visible or not, remove the battery from use and dispose of it properly.

- **If the battery shows signs of damage or signs of leakage, replace it immediately. Use caution in removing the battery. Avoid contacting the leakage.**
 - **Extremely high ambient temperature may cause battery overheat protection, resulting in pump shutdown.**
 - **The lithium-ion battery has a service life. Replace your battery when it reaches the end of its service life. Failure to replace the battery may cause serious damage to your pump from battery overheating.**
 - **Do not open the battery, heat the battery above 60 °C, incinerate battery, or short battery terminals. They may ignite, explode, leak or heat up, causing personal injury.**
-

NOTE:

- Remove the battery if it will not be used for an extended period of time.
 - The battery should be charged only in this pump.
 - Storing the battery at high temperature for an extended period of time will significantly shorten their life expectancy.
 - Storing the battery in a cool place can slow the aging process. Ideally the battery should be stored at 15 °C.
 - If the battery is not conditioned for a prolonged time, its charge indication may not be accurate and you may wrongly evaluate the remaining battery runtime.
 - Do not use the pump for infusion during battery conditioning.
 - Do not interrupt battery conditioning.
 - A total loss of power has no impact on the history records stored.
-

11.3.2 Installing the Battery

The battery must only be installed by service personnel trained and authorized by Mindray Animal Medical. To install the battery, contact your service personnel. The battery is installed when the pump leaves the factory.

Replace a battery in the following situations:

- The battery has visual signs of damage or the battery fails.
- The battery is aged and its runtime significantly shorter than the specification.
- The battery service life expires.

11.3.3 Charging the Battery

To optimize performance, a fully or nearly fully discharged battery should be charged as soon as possible. The battery is recharged automatically when the pump is connected to AC mains power.

11.3.4 Conditioning the Battery

The service life of a battery depends on how frequent it is used. When properly used, the lithium-ion battery has a service life of approximately three years. If improperly used, its service life can be

shorten. We recommend replacing the battery every three years. The performance of the battery deteriorates over time. You should condition the battery every four months.

To condition a battery, follow this procedure:

1. Disconnect the pump from the animal.
2. Turn off the pump, and connect the pump to the external power.
3. Allow the battery to be charged uninterruptedly till it is fully charged.
4. Disconnect the pump from the external power source, and turn on the pump.
5. Allow the pump to run on the battery until the battery is completely depleted and the pump automatically shuts down. Fully charge the battery again for use or charge it to 40 – 60% for storage.

11.4 Disposing of the Pump

The service life of this pump is ten years. Dispose of the pump when its service life is reached. Follow local regulations regarding the disposal of such product.

WARNING

For disposal of parts, batteries, packaging materials, and accessories, where not otherwise specified, follow local regulations regarding disposal of hospital waste.

12 Care and Cleaning

In this chapter we only describe cleaning and disinfection of the pump. For the cleaning and disinfection of other accessories, refer to their instructions for use.

12.1 Care and Cleaning Safety Information

WARNING

- **Use only the approved cleaners, disinfectants and methods listed in this chapter to clean and disinfect your pump. Warranty does not cover damage caused by unapproved substances or methods.**
 - **Do not mix disinfecting solutions, as hazardous gases may result.**
 - **We make no claims regarding the efficacy of the listed chemicals or methods as a means for controlling infection. For the method to control infection, consult your hospital's infection control officer or epidemiologist.**
 - **The responsible hospital or institution shall carry out all cleaning and disinfection procedures specified in this chapter.**
-

CAUTION

- **Turn off the pump and remove the power cord from the pump before cleaning and disinfecting.**
 - **Never immerse any part of the pump or accessories in liquids or allow liquid to enter the interior of the pump or accessories.**
 - **Any contact of cleaners or disinfectants with connectors or metal parts may cause corrosion.**
 - **Do not pour or spray any liquid directly on the pump or accessories or permit fluid to seep into connections or openings.**
 - **If you spill liquid on the pump or accessories, disconnect the power supply, dry the pump, and contact your service personnel.**
 - **Never use abrasive materials (such as steel wool or silver polish), or erosive cleaners (such as acetone or acetone-based cleaners).**
 - **Dilute and use the cleaners or disinfectants according to the manufacturer's instructions.**
 - **Check the pump after cleaning and disinfecting. If there is any sign of damage, remove it from use.**
-

12.2 Cleaning and Disinfection of the Pump

- The supported cleanser includes: water and ethanol (70%).
- The supported disinfectant includes: ethanol (70%)
- The supported cleaning tools include: absorbent cotton ball, soft gauze, soft brush, and soft cloth.

Clean and disinfect the pump on a regular basis. Before cleaning and disinfection, consult your hospital's regulations.

To clean and disinfect the pump, follow this procedure:

1. Dampen a soft lint-free cloth with the cleanser or disinfectant.
2. Wring excess liquid from the cloth.
3. Wipe the display screen of the pump.
4. Wipe the external surface of the pump with the damp cloth, avoiding the connectors and metal parts.
5. Dry the surface with a clean cloth. Allow the pump air dry in a ventilated and cool place.

12.3 Sterilization

Sterilization is not recommended for this pump, related products, accessories, or supplies unless otherwise indicated in the Instructions for Use that accompany the products, accessories or supplies.

13 Accessories

The accessories listed in this chapter comply with the requirements of IEC 60601-1 when in use with the pump. For details about the accessories, refer to the instructions for use provided with the accessory.

WARNING

Use accessories specified in this chapter. Using other accessories may cause damage to the pump or not meet the claimed specifications.

CAUTION

- The accessories may not meet the performance specifications if stored or used outside the specified temperature and humidity ranges. If accessory performance is degraded due to aging or environmental conditions, contact your service personnel.
- Check the accessories and their packages for any sign of damage. Do not use them if any damage is detected.
- Use the accessories before the expiry date if their expiry date is indicated.

PN	Description
0020-20-12522	Power cord, 10A, 250V, 2.5m, International
009-001791-00	Power cord, 250V, 16A, 3m, South Africa
009-002636-00	Power cord, 10A, 1.5m, Australia standard
009-007190-00	Power cord, 3m, India
DA8K-10-14452	Power cord, USA
DA8K-10-14453	Power cord, UK
DA8K-10-14454	Power cord, Europe
009-014769-00	DC power cord
115-089928-00	Pole clamp

A Product Specifications

A.1 Specifications

Classifications	<ul style="list-style-type: none"> • Connect to AC power source, type of protection against electrical shock: CLASS I EQUIPMENT, equipment energized from an internal electrical power source • Degree of protection against electrical shock: Defibrillation-proof type CF applied part (direct cardiac application) • Mode of operation: Continuous • Degree of protection against harmful ingress of water: IP44
Operating conditions	<ul style="list-style-type: none"> • Temperature: 5°C to 40°C • Relative humidity: 15% to 95%, noncondensing • Barometric: 57.0 kPa to 107.4 kPa
Storage conditions	<ul style="list-style-type: none"> • Temperature: -20°C to 60°C • Relative humidity: 10% to 95%, noncondensing • Barometric: 16.0 kPa to 107.4 kPa • Corrosive-free and ventilated
Power Supply	<ul style="list-style-type: none"> • AC Power Supply: 100 V to 240 V, 50/60 Hz, 0.30A to 0.13A • DC Power Supply: 10 V to 16 V, 2.0A to 1.3A
Battery run time	<p>At least 6.5 hours for normal battery (operating at a rate of 5ml/h, under standard operating conditions*)</p> <p>*Operating with a fully charged new battery at 20°C ± 2°C, default screen brightness and volume, Wi-Fi disabled, without accessories.</p>
Battery charge time	≤ 5 hours for normal battery (the pump is off, and charged by the AC power supply).
Shutdown delay	At least 30 minutes after first low battery alarm
Main unit weight	≤ 1.7 kg (with normal battery, without pole clamp)
Main unit (W × D × H)	252 mm x 118 mm x 134 mm (without pole clamp, the error is ±3 mm)
Display	3.5 inches Color TFT LCD, resolution ≥ 320x480 pixels
Speaker	<ul style="list-style-type: none"> • Gives alarm tones (sound pressure 50 to 75 dB). • Supports multi-level tone modulation. • Alarm tones comply with IEC 60601-2-24:2012.

NOTE:

- The equipment is not suitable for use in the presence of a flammable anesthetic mixture with air or with oxygen or nitrous oxide.
- When stored under temperature conditions beyond the defined operating conditions, the equipment needs to be placed under room temperature at least one hour before use.
- The pump may not meet the performance specifications if stored or used outside the specified temperature and humidity ranges. If the performance of the equipment is degraded due to aging or environmental conditions, contact your service personnel.

A.2 Wireless Network

Standards	IEEE 802.11a/b/g/n
Modulation mode	BPSK, QPSK, 16-QAM, 64-QAM
Operating frequency	<ul style="list-style-type: none"> • 2412MHz to 2472MHz • 5180MHz to 5320MHz • 5500MHz to 5700MHz • 5745MHz to 5825MHz
Data rate	<ul style="list-style-type: none"> • IEEE 802.11a: 6 to 54 Mbps • IEEE 802.11b: 1 to 11 Mbps • IEEE 802.11g: 6 to 54 Mbps • IEEE 802.11n: MCS0 to MCS7
Transfer power	<ul style="list-style-type: none"> • < 20 dBm (CE requirement: detection mode – RMS) • < 30 dBm (FCC requirement: detection mode – PEAK)
Operating mode	Transmitting data through the wireless access point (AP)
Data security	<ul style="list-style-type: none"> • Standard: OPEN and WPA/WPA2-PSK • Encryption: TKIP and AES
System capacity	Number of the pumps supported by a single AP: ≤16
Data transmission delay between the pump and the CMS	Total data transmission delay time between the pump and the CMS is ≤ 8s
Interruption number and time between the pump and the CMS	Total interruption duration ≤0.01* total communication time (Test within 24 hours, with 16 pumps, in which three pumps are roaming for 30 times)
Delay time of network disconnection alarm	≤ 14 s

A.3 Infusion Specifications

Compatible syringe sizes	2ml/3ml, 5ml/6ml, 10ml/12ml, 20ml, 30ml/35ml, 50ml/60ml
--------------------------	---

Accuracy	<ul style="list-style-type: none"> Mechanical accuracy: $\leq \pm 0.5\%$ Infusion accuracy: $\leq \pm 1.8\%$ (under standard operating conditions, test in accordance with IEC60601-2-24) *Infusion accuracy use Double-Dove and B.Braun Original Perfusor Syringe, under standard operating conditions, test in accordance with IEC60601-2-24)
Remaining infusion time error	$\pm 10\%$
Set range of the infusion rate/purge rate/bolus rate	<ul style="list-style-type: none"> 0.01 to 150ml/h (2/3ml syringe) 0.01 to 300ml/h (5/6ml syringe) 0.1 to 800ml/h (10/12ml syringe) 0.1 to 1200ml/h (20ml syringe) 0.1 to 1500ml/h (30/35ml syringe) 0.1 to 2300ml/h (50ml/60ml syringe and 60ml syringe) Resolution: <ul style="list-style-type: none"> 0.01ml/h (0.01 to 99.99ml/h) 0.1ml/h (100.0 to 999.9ml/h) 1ml/h(1000 to 2300ml/h)
Occlusion pressure	<ul style="list-style-type: none"> 50mmHg to 1125mmHg Resolution: 1mmHg 1000mmHg to 1125mmHg: not applicable for 50ml/60ml syringe The maximum occlusion pressure is 1350mmHg.
Occlusion pressure tolerance	<ul style="list-style-type: none"> 50mmHg to 149mmHg: $\leq \pm 75\text{mmHg}$ (operating at a rate $\leq 100\text{ ml/h}$) 150mmHg to 1125mmHg: $\leq \pm 20\%$ or $\leq \pm 125\text{mmHg}$, whichever is greater (operating at a rate $\geq 0.1\text{ml/h}$)
Maximum volume (under single fault conditions)	$\leq 0.2\text{ml}$
KVO rate	<ul style="list-style-type: none"> 0.01 to 5.0ml/h Minimum resolution: 0.01ml/h
Time set range	00:00:01 to 99:59:59 (h:min:sec)
VTBI set range	<ul style="list-style-type: none"> 0.01 to 9999.99 ml Minimum resolution: 0.01ml Micro-infusion mode: 0.01 to 1000ml
Weight set range	0.1 to 499.0 kg/0.2 to 1100.1 lb
Drug Amt. set range	0.001 to 99999
Drug Amt. unit	ng, μg , mg, g, mU, U, kU, EU, mmol, mol, mcal, cal, kcal, mEq
Volume set range in Dose Time Mode/Dose Mode/TIVA Mode	0.1 to 9999.99ml
Conc. set range	0.001 to 9999.99
Conc. unit set range	ng/ml, $\mu\text{g/ml}$, mg/ml, g/ml, mU/ml, U/ml, kU/ml, EU/ml, mmol/ml, mol/ml, mcal/ml, cal/ml, kcal/ml, mEq/ml

Dose Rate set range	0.001 to 99999
---------------------	----------------

WARNING

The infusion accuracy and pressure detection is affected by viscosity of liquids and disposables used (for example diameter, plunger, material, and needle).

NOTE:

The infusion accuracy tests and occlusion pressure tests are performed in accordance with IEC60601-2-24:2012 (test temperature: 20°C ± 2°C).

A.4 Recommended Syringes

Product Name	Size	Manufacturer
Sterile Hypodermic Syringes for Single Use	5ml, 10ml, 20 ml, 30 ml, 50ml	Double-Dove
B. Braun Original Perfusor Syringe	20ml, 50ml	B. Braun Melsungen AG

NOTE:

- The recommended extension set is B.Braun Original Perfusor Line (using IV-Standard-PE, and with Luer lock).
- The pump will not affect the quality of disposables from other suppliers. Changes in quality may affect the technical data of the pump. Mindray Animal Medical is not responsible for such changes.

A.5 Occlusion Alarm Delay and Bolus Volume

The maximum alarm delay after occlusion is as follows:

Syringe size (ml)	Rate (ml/h)	Occlusion alarm delay time (hh: mm: ss)		
		High occlusion alarm pressure level	Medium occlusion alarm pressure level	Low occlusion alarm pressure level
20	/			
	1	<00:52:00	<00:32:26	<00:03:55
	5	<00:09:05	<00:05:51	<00:00:45

Syringe size (ml)	Rate (ml/h)	Occlusion alarm delay time (hh: mm: ss)		
		High occlusion alarm pressure level	Medium occlusion alarm pressure level	Low occlusion alarm pressure level
50	/	High occlusion alarm pressure level	Medium occlusion alarm pressure level	Low occlusion alarm pressure level
	1	<02:43:48	<01:45:18	<00:09:28
	5	<00:32:07	<00:17:14	<00:03:53

- Syringe brand: B.Braun Original Perfusor Syringe
- Extension line: 1m
- Test temperature: 20°C ±2°C

Syringe size (ml)	Rate (ml/h)	Bolus volume after occlusion (ml)		
		High occlusion alarm pressure level	Medium occlusion alarm pressure level	Low occlusion alarm pressure level
/	/	High occlusion alarm pressure level	Medium occlusion alarm pressure level	Low occlusion alarm pressure level
20	5	< 0.2	<0.15	< 0.1
/	/	High occlusion alarm pressure level	Medium occlusion alarm pressure level	Low occlusion alarm pressure level
50	5	< 0.3	< 0.25	< 0.15

- Syringe brand: B.Braun Original Perfusor Syringe
- Extension line: 1m
- Test temperature: 20°C ±2°C

WARNING

Occlusion alarm pressure, alarm delays and bolus volume may vary depending on test conditions, temperature and tube length. Using syringe of a larger size and infusing at a lower rate may cause longer occlusion alarm delay.

A.6 Infusion Accuracy Graphs

A.6.1 Infusion Accuracy at 1 ml/h

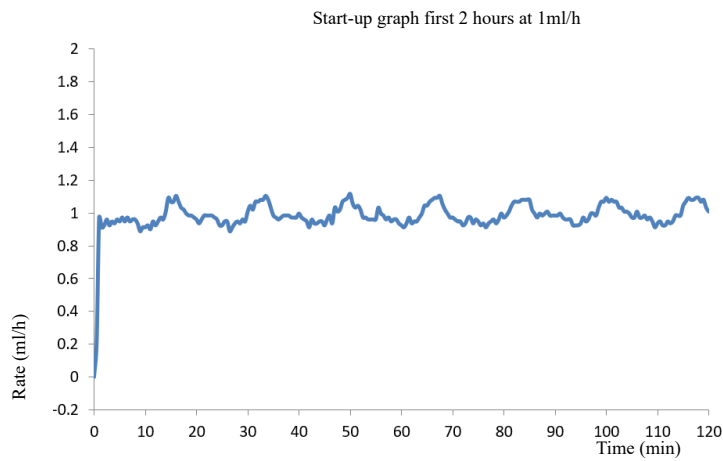
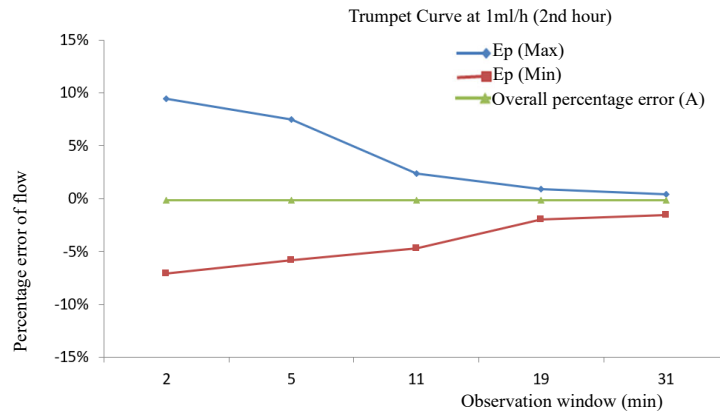

A.6.2 Infusion Accuracy at 5ml/h

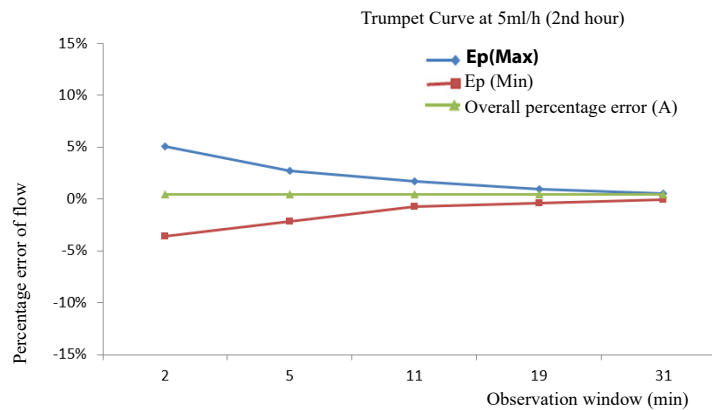

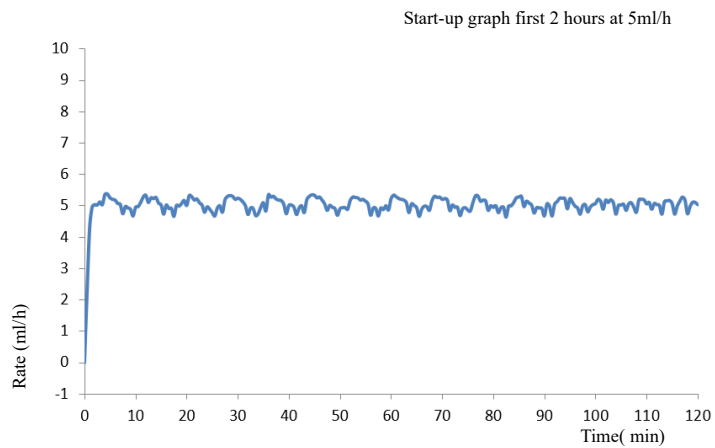

Test conditions:

- Syringe brand: B.Braun Original Perfusor Syringe, B.Braun extension set
- Syringe size: 50ml
- Test interval: $\Delta t = 0.5$ minute

⚠ WARNING

Infusion accuracy may be influenced by the pump's environment (such as pressure, temperature, humidity, and any infusion consumables used).

B EMC and Radio Regulatory Compliance

B.1 EMC

The device meets the requirements of IEC 60601-1-2:2014+A1:2020.

WARNING

- **Use of accessories, transducers and cables other than those specified or provided by the manufacturer of this device could result in increased electromagnetic emissions or decreased electromagnetic immunity of this device and result in improper operation.**
 - **Use of this device adjacent to or stacked with other device should be avoided because it could result in improper operation. If such use is necessary, this device and the other device should be observed to verify that they are operating normally.**
 - **Portable RF communications pump (including peripherals such as antenna cables and external antennas) should be used no closer than 30 cm (12 inches) to any part of this device, including cables specified by the manufacturer. Otherwise, degradation of the performance of this device could result.**
 - **The non-ME EQUIPMENT (e.g. ITE) that is a part of an ME SYSTEM may be disrupted by the electromagnetic interference of nearby equipment. It may be necessary to take mitigation measures, such as re-orienting or relocating the non-ME EQUIPMENT or shielding the location.**
 - **This device is intended for use in professional healthcare facility environment only. If it is used in special environment, such as magnetic resonance imaging environment, the device may be disrupted by the operation of nearby equipment.**
-

NOTE:

- The device needs special precautions regarding EMC and needs to be installed and put into service according to the EMC information provided below.
- Use of portable or mobile communications devices will degrade the performance of the device.
- Other devices may affect this device even though they meet the requirements of CISPR.
- If the essential performance is lost or degraded, it may be necessary to take mitigation measures, such as re-orienting or relocating the ME EQUIPMENT or ME SYSTEM or shielding the location or stopping using the pump system and contact the service personnel.

If the device is operated within the electromagnetic environment listed in Table **Guidance and Declaration —Electromagnetic Immunity**, the system will remain safe and provide the following essential performance:

- Operating mode
- Accuracy
- Function
- Protection against UNINTENDED BOLUS volumes
- Occlusion
- ALARM CONDITIONS regarded
- Data stored

Guidance and Declaration - Electromagnetic Emissions

The device is intended for use in the electromagnetic environment specified below. The customer or the user of the device should assure that it is used in such an environment.

Emission test	Compliance	Electromagnetic environment - guidance
Radiated RF EMISSIONS CISPR 11	Group 1	The device uses RF energy only for its internal function. Therefore, its RF emissions are very low and are not likely to cause any interference in nearby electronic device.
Conducted RF EMISSIONS CISPR 11	Class A	The device is suitable for use in all establishments, including domestic establishments and those directly connected to the public low-voltage power supply network that supplies buildings used for domestic purposes.

Guidance and Declaration - Electromagnetic Immunity

The device is intended for use in the electromagnetic environment specified below. The customer or the user of the device should assure that it is used in such an environment.

Immunity test	IEC 60601 test level	Compliance level	Electromagnetic environment - guidance
Electrostatic discharge (ESD) IEC 61000-4-2	±8 kV contact ±15 kV air	±8 kV contact ±15 kV air	Floors should be wood, concrete or ceramic tile. If floors are covered with synthetic material, the relative humidity should be at least 30%.
Electrical fast transient/burst IEC 61000-4-4	±2 kV 100 kHz repetition frequency	±2 kV 100 kHz repetition frequency	Mains power quality should be that of a typical commercial or hospital environment.
Surge IEC 61000-4-5	±1kV (Line to line) ±2kV (Line to ground)	±1kV (Line to line) ±2kV (Line to ground)	
Voltage dips and Voltage interruptions IEC 61000-4-11	<ul style="list-style-type: none"> • Voltage Test Level: 0% U_T Voltage Dip: 100% U_T Duration: 0.5 cycle at 0°, 45°, 90°, 135°, 180°, 225°, 270° and 315° • Voltage Test Level: 0% U_T Voltage Dip: 100% U_T Duration: 1 cycle at 0° • Voltage Test Level: 70% U_T Voltage Dip: 30% U_T Duration: 25/30 cycles at 0° • Voltage Test Level: 0% U_T Voltage Dip: 100% U_T Duration: 250/300 cycles 	<ul style="list-style-type: none"> • Voltage Test Level: 0% U_T Voltage Dip: 100% U_T Duration: 0.5 cycle at 0°, 45°, 90°, 135°, 180°, 225°, 270° and 315° • Voltage Test Level: 0% U_T Voltage Dip: 100% U_T Duration: 1 cycle at 0° • Voltage Test Level: 70% U_T Voltage Dip: 30% U_T Duration: 25/30 cycles at 0° • Voltage Test Level: 0% U_T Voltage Dip: 100% U_T Duration: 250/300 cycles 	Mains power quality should be that of a typical commercial or hospital environment. If the user of our product requires continued operation during power mains interruptions, it is recommended that our product be powered from an uninterruptible power supply or a battery.

RATED power frequency magnetic fields IEC 61000-4-8	30 A/m 50 Hz or 60 Hz	30 A/m 50 Hz or 60 Hz	Power frequency magnetic fields should be at levels characteristic of a typical location in a typical commercial or hospital environment.
--	--------------------------	--------------------------	---

Note: U_T is the A.C. mains voltage prior to application of the test level.

Guidance and Declaration - Electromagnetic Immunity

The device is intended for use in the specified electromagnetic environment. The customer or the user of the device should assure that it is used in such an environment as described below.

Immunity test	IEC 60601 test level	Compliance level	Electromagnetic environment - guidance
Conducted disturbances induced by RF fields IEC 61000-4-6	3 Vrms 0.15 MHz to 80 MHz	3 Vrms	Portable and mobile RF communications equipment should be used no closer to any part of the device, including cables, than the recommended separation distance calculated from the equation applicable to the frequency of the transmitter. Recommended separation distance: $d = \left[\frac{3.5}{V} \right] \sqrt{P}$ 150kHz to 80 MHz $d = \left[\frac{3.5}{V} \right] \sqrt{P}$ 80 MHz to 800 MHz
	6 Vrms in ISM bands ^a and amateur radio bands between 0,15 MHz and 80 MHz	6 Vrms	
Radiated RF EM fields IEC 61000-4-3	10V/m 80 MHz to 2.7 GHz	3V/m	$d = \left[\frac{3.5}{V} \right] \sqrt{P}$ 800 MHz to 2.7 GHz where P is the maximum output power rating of the transmitter in watts (W) according to the transmitter manufacturer and d is the recommended separation distance in meters (m). Field strengths from fixed RF transmitters, as determined by an electromagnetic site survey ^b , should be less than the compliance level in each frequency range ^c .
Proximity fields from RF wireless communications equipment IEC 61000-4-3	27 V/m 380–390 MHz	27 V/m	Interference may occur in the vicinity of equipment marked with the following symbol: 
	28 V/m 430–470 MHz, 800–960 MHz, 1700–1990 MHz, 2400–2570 MHz	28 V/m	
	9 V/m 704–787 MHz, 5100–5800 MHz	9 V/m	

Note 1: At 80 MHz and 800 MHz, the higher frequency range applies.

Note 2: These guidelines may not apply in all situations. Electromagnetic propagation is affected by absorption and reflection from structures, objects and people.

^a The ISM (industrial, scientific, and medical) bands between 150 kHz and 80 MHz are 6.765 MHz to 6.795 MHz; 13.553 MHz to 13.567 MHz; 26.957 MHz to 27.283 MHz; and 40.66 MHz to 40.70 MHz. The amateur radio bands between 0,15 MHz and 80 MHz are 1,8 MHz to 2,0 MHz, 3,5 MHz to 4,0 MHz, 5,3 MHz to 5,4 MHz, 7 MHz to 7,3 MHz, 10,1 MHz to 10,15 MHz, 14 MHz to 14,2 MHz, 18,07 MHz to 18,17 MHz, 21,0 MHz to 21,4 MHz, 24,89 MHz to 24,99 MHz, 28,0 MHz to 29,7 MHz and 50,0 MHz to 54,0 MHz.

^b Field strengths from fixed transmitters, such as base stations for radio (cellular/cordless) telephones and land mobile radios, amateur radio, AM and FM radio broadcast and TV broadcast cannot be predicted theoretically with accuracy. To assess the electromagnetic environment due to fixed RF transmitters, an electromagnetic site survey should be considered. If the measured field strength in the location in which the device is used exceeds the applicable RF compliance level above, the device should be observed to verify normal operation. If abnormal performance is observed, additional measures may be necessary, such as re-orienting or relocating the device.

^c Over the frequency ranges 150 kHz to 80 MHz, field strengths should be less than 3V/m.

Recommended Separation Distances between Portable and Mobile RF, Communications Equipment and the device

The device is intended for use in an electromagnetic environment in which radiated RF disturbance are controlled. The customer or the user of the device can help prevent electromagnetic interference by maintaining a minimum distance between portable and mobile RF communications equipment (transmitters) and the device as recommended below, according to the maximum output power of the communication equipment.

Rated Maximum Output power of Transmitter Watts (W)	Separation Distance According to Frequency of Transmitter (m)		
	150 kHz to 80 MHz $d = \left[\frac{3,5}{f} \right] \sqrt{P}$	80 MHz to 800 MHz $d = \left[\frac{3,5}{f} \right] \sqrt{P}$	800 MHz to 2.7 GHz $d = \left[\frac{3,5}{f} \right] \sqrt{P}$
0.01	0.12	0.12	0.23
0.1	0.38	0.38	0.73
1	1.2	1.2	2.3
10	3.8	3.8	7.3
100	12	12	23

For transmitters at a maximum output power not listed above, the recommended separation distanced in meters (m) can be determined using the equation applicable to the frequency of the transmitter, where P is the maximum output power rating of the transmitter in watts (W) according to the transmitter manufacturer.

Note 1: At 80 MHz and 800 MHz, the higher frequency range applies.

Note 2: These guidelines may not apply in all situations. Electromagnetic propagation is affected by absorption and reflection from structures, objects and people.

B.2 Radio Regulatory Compliance

Refer to “A.2 Wireless Network” for the details of RF parameters. Refer to “A.2 Wireless Network” for the details of RF parameters.



The radio device used in this product is in compliance with the essential requirements and other relevant provisions of Directive 2014/53/EU.

 **WARNING**

Keep a distance of at least 20cm away from the pump when Wi-Fi function is in use.

C Abbreviations

Abbreviation	Full Name
AC	Alternating Current
Anti-Bolus	Anti-Bolus
BOLUS	Bolus
CCU(CICU)	Cardiac Intensive Care Unit
CE	Conformité Européenne
CISPR	International Special Committee on Radio Interference
CPU	Central Processing Unit
DC	Direct Current
DERS	Dose Error Reduction Systems
DPS	Dynamic Pressure System
EEC	European Economic Community
EMC	Electromagnetic Compatibility
EMI	Electromagnetic Interference
EtO	Ethylene oxide
ICU	Intensive Care Unit
ID	Identification
IEC	International Electrotechnical Commission
IEEE	Institute of Electrical and Electronic Engineers
ISO	International Organization for Standardization
IV	Intravenous
KVO	Keep Vein Open

Abbreviation	Full Name
LED	Light Emitting Diode
Max	Maximum
Min	Minimum
MRI	Magnetic Resonance Imaging
N/A	Not Applied
OR	Operating Room
SN	Series Number
USB	Universal Serial Bus
VTBI	Volume To Be Infused

D Declaration of Conformity

DoC – V1.0

DECLARATION OF CONFORMITY 

Manufacturer: Shenzhen Mindray Animal Medical Technology Co., Ltd.
Address: Room 702, Tower 4, YESUN Intelligent Community III, No.1301-88 Guanguang Road,
 Xinlan Community, Guanlan Street, Longhua District, Shenzhen 518110, P. R. China

declares under our sole responsibility that the mentioned product below:

Device: *Veterinary Syringe Pump*
Model: *AniFM S3*

is in conformity with the essential requirements of the Community harmonization legislation listed below:

Directive 2014/53/EU – Radio Equipment

Standards Applied:

EN 60601-1:2006+A1:2013+A2:2021	EN 60601-1-2:2015+A1:2021
EN IEC 62311:2020	ETSI EN 301 489-1 V2.2.3
ETSI EN 301 489-17 V3.2.4	ETSI EN 300 328 V2.2.2
ETSI EN 301 893 V2.1.1	EN IEC 62368-1:2020+A11:2020

Place, Date of Issue: **Shenzhen, 2023-07-05**

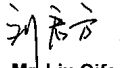
Signature: 

Name of Authorized Signatory: **Mr. Liu Qifang**
Position Held in Company: **General Technology R&D Department Manager**

DoC – V1.0

**UK
CA**

UK DECLARATION OF CONFORMITY

Manufacturer: Shenzhen Mindray Animal Medical Technology Co., Ltd.
Address: Room 702, Tower 4, YESUN Intelligent Community III, No.1301-88 Guanguang Road, Xinlan Community, Guanlan Street, Longhua District, Shenzhen 518110, P. R. China

declares under our sole responsibility that the mentioned product below:

Device: Veterinary Syringe Pump
Model: AniFM S3

is in conformity with the essential requirements of the UK Statutory Instruments (including amendments) listed below:

S.I. 2017 No. 1206 – The Radio Equipment Regulations 2017

Standards Applied:

BS EN 60601-1:2006+A2:2021	BS EN 60601-1-2:2015+A1:2021
BS EN IEC 62311:2020	ETSI EN 301 489-1 V2.2.3
ETSI EN 301 489-17 V3.2.4	ETSI EN 300 328 V2.2.2
ETSI EN 301 893 V2.1.1	BS EN IEC 62368-1:2020+A11:2020

Place, Date of Issue: Shenzhen, 2023-07-05

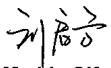
Signature: 

Name of Authorized Signatory: Mr. Liu Qifang
Position Held in Company: General Technology R&D Department Manager

